

Electronic Enclosures & Accessories



5500 E Jurupa Street
Ontario CA, 91761
800-767-9378
sales@pmpwest.com

**PREMIER'S
RESULTS**



Detail of Pagoda Top and Lifting Eyebolts



Front view of Three Bay EMI Shielded Cabinet

Side view of Forklift Base

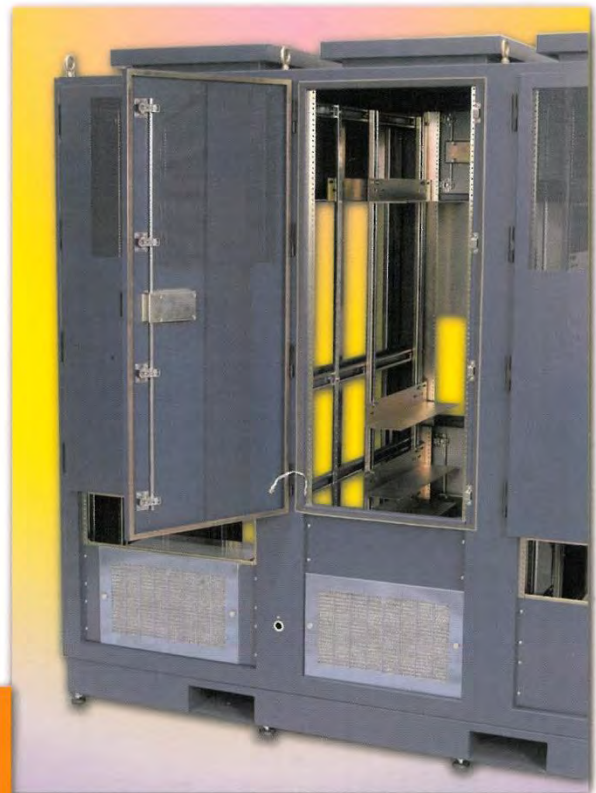
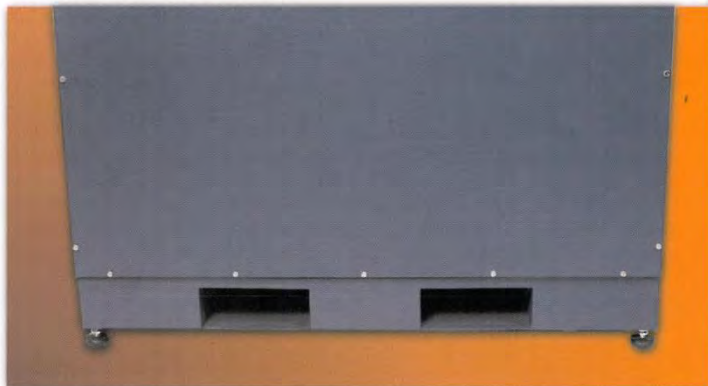

Rear view of Three Bay EMI Shielded Cabinet

PREMIER

First in design and manufacture of Sheet Metal Enclosures and Chassis, Standard or Customized to Specifications.

COMMITMENT

Premier is committed to expanding its leadership in the design, engineering, and manufacturing of enclosures and chassis, providing a standard product line with the ability to modify the standard line of product and to design, engineer and manufacture custom enclosures with the responsiveness, service, quality and technical expertise surpassing the current business environment.

SERVICE

The commitment to service is paramount in the continued success demonstrated at Premier. Premier's responsiveness to solving customer issues, such as quotations, order status, product support, and technical information efficiently and courteously characterizes the mission emphasized by the staff at Premier.

QUALITY

Quality is the focus which underscores all business today. Terms such as world class manufacturing, just in time, and 100% defect free reflect the changing business conditions of which Premier has directed its efforts. Premier has paced itself to meet the growth and demands of the future. Dedication to the continued investment in facilities, equipment, and personnel produces a responsible business climate for all to thrive.

The management team and its employees are dedicated to providing the highest reliability by manufacturing all products to military standard 45208a.

INNOVATION

Over 50 years of experience and emphasis on innovation continues to form the core of Premier's business philosophy. Premier's promise of Innovation Thru Engineering, provides customer with the best engineering support available, both in the field and the factory.

The Premier engineering department provides design packages from conceptual sketches to finished documented drawings for aerospace, telecommunicating, O.E.M.'s, military contractors, bio-medical firms, security/video organizations, just to name a few.



Two Bay System with Circuit Breakers / Rear Doors with Filters

CAPABILITY

Premier's state of the art CAD/CAM software, allows 3D/2D drawings to be transferred directly into CNC programs, maintaining dimensions and tolerance to specifications. Continuous growth and improvements of manufacturing processes facilitated by aggressive planning enhances productivity and continuity of manufacturing.

SPECIALIZATIONS



**EMI / RFI Seismic Rack
Zone -4**

EMI

Premier engineers EMI shielded enclosures to protect against electromagnetic interference for commercial, military and high-security applications.

NEMA

Premier builds modified and custom National Electrical Manufacturing Association (NEMA) enclosures to meet unique environmental requirements.

Seismic/Shock/Vibration

Premier designs seismic enclosures to meet shock and vibration requirements. We have the expertise and knowledge to meet special requirements, such as those that stipulate zone 4 or under Belcore specifications.



**EMI / RFI Seismic Rack
Zone -4**

Standard Vertical Panel Electronic Enclosures

TVA	5 - 6
SVA	7 - 8

Sloped Front Enclosures

TSA	9 - 10
SSA	11

Wedges

Trimline & Spartan Wedges	12
---------------------------------	----

LAN/File Server Cabinets

LAN Management

LAN, LAF	13 - 14
----------------	---------

MaxiFlow File Server Cabinets

FSA	15
-----------	----

Accessories

Panels, EIA Standard

Steel Formed	
FP, FPL, PFP	17
Steel Flat	
RP, GRP	18
Aluminum, Flat	
ARP, MAP	18
Side Hinged	
SHP	18
Flush Mount Door	
CD	18

Writing Shelves

TWS (Stationary)	18
------------------------	----

Drawers & Shelves

TDR (Sliding Drawer)	19
TWS (Sliding Writing Shelf)	19
TES (Stationary Shelf)	19
TCS (Support Angle)	19
RSC, RSH (Stationary Shelf)	20
RSS, RSK (Sliding Shelf)	20

Equipment & Shelf Supports

TCS (Support Angle)	19
PMA, PMAT (Mounting Angles)	17
RFK (Keyboard Shelf)	19
TFP (Top Filler Panel)	19
ATD (Anti-Tipping Device)	19

Slides (Chassis Equipment)

SBB	21
-----------	----

Fans & Blowers

EF, PMB	21
---------------	----

Power Outlet Strips

OB	22
----------	----

Handles and Hardware

HW	23
----------	----

Casters

CA	23
----------	----

TVA-6119-23-2B with Plexiglas front door TVD-P-6119



Trimline TVA Series — Vertical Enclosures

Finished in all standard Premier colors. If not specified, Smoke Blue Textured will be furnished.

Typical Trimline TVA Series enclosures shown with plexiglas and painted metal doors.

30° and 45° matching wedge frames are available for multiple bay console configurations. (See Page 12)



PT Series Pagoda Tops available on special order

All features shown are standard in the Trimline TVA Series. Welded, formed steel construction.

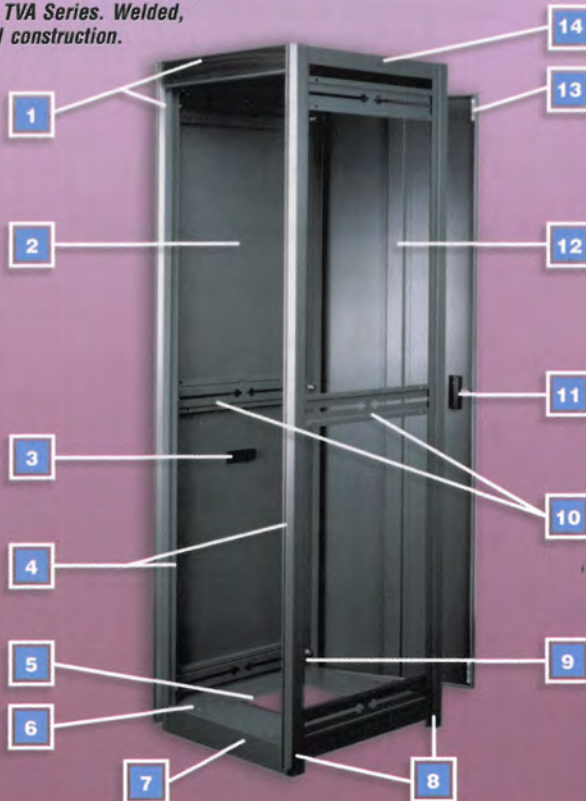

TVA Series Vertical Assembly Construction Details

(1 frame, 2 end panels, rear door) All features shown are standard in the Trimline TVA Series. Welded, formed steel construction.

- 1** Trim: extruded anodized aluminum with textured vinyl inlays provide 1" recess for door mounting or panel area
- 2** Outside removable flush end panels (18 gauge)
- 3** Recessed hand grip for panel removal
- 4** 2 pr. panel mounting angles, fully adjustable front to rear with tapped 10-32 holes on EIA Standards spacing (12 gauge plated)
- 5** 10" x 10" cut-out for cable entry beneath base (optional)
- 6** Recessed caster mounting holes
- 7** 1 piece formed steel base provides for heavy equipment mounting area and concealed caster mounting (14 gauge)
- 8** Formed steel uprights (14 gauge) provide 1/2" recess to panel mounting angles
- 9** Quick release, spring loaded door hinges (top and bottom)
- 10** Horizontal cross-brace and panel mounting angle support
- 11** Keyed lock with flush handle
- 12** Door stiffener channel
- 13** Magnetic closure
- 14** 1 piece solid top for extra rigidity and squareness (14 gauge)

Vertical Enclosures

Basic Nominal Sizes

FRONT VIEW

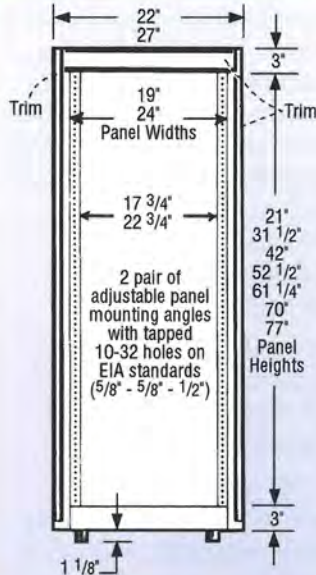

SIDE VIEW

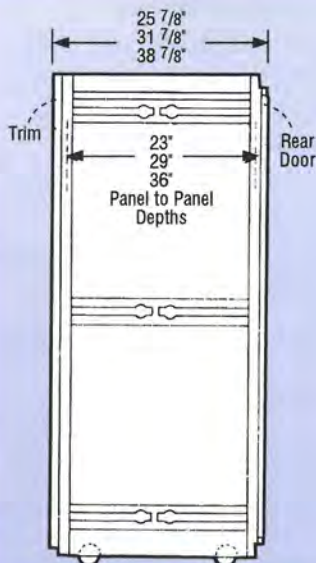

ORDERING INSTRUCTIONS

Select basic requirements for frame height, width and depth in the dimensional drawings; then select the assembly model number from the tables, which will include the frame, 2 side panels, rear door, specified trim and color finish, assembled in 1 unit.

Modifications and accessories may be ordered as required.

Ordering Information

Assemblies

Assemblies include frame with trim and 2 pairs of adjustable panel mounting angles (tapped with 10-32 holes on EIA spacing); 2 outside removable side panels; rear mounted door with handle, lock and 2 keys. (Door hinged right unless otherwise specified.)

Vertical Panel Height (Inches)	19 Inch Panel Width Panel-to-Panel Depth (Inches)		
	23	29	36
21	TVA-2119-23	TVA-2119-29	TVA-2119-36
31 1/2	TVA-3119-23	TVA-3119-29	TVA-3119-36
42	TVA-4219-23	TVA-4219-29	TVA-4219-36
52 1/2	TVA-5219-23	TVA-5219-29	TVA-5219-36
61 1/4	TVA-6119-23	TVA-6119-29	TVA-6119-36
70	TVA-7019-23	TVA-7019-29	TVA-7019-36
77	TVA-7719-23	TVA-7719-29	TVA-7719-36
Vertical Panel Height (Inches)	24 Inch Panel Width		
	23	29	36
21	TVA-2124-23	TVA-2124-29	TVA-2124-36
31 1/2	TVA-3124-23	TVA-3124-29	TVA-3124-36
42	TVA-4224-23	TVA-4224-29	TVA-4224-36
52 1/2	TVA-5224-23	TVA-5224-29	TVA-5224-36
61 1/4	TVA-6124-23	TVA-6124-29	TVA-6124-36
70	TVA-7024-23	TVA-7024-29	TVA-7024-36
77	TVA-7724-23	TVA-7724-29	TVA-7724-36

To order frames only, substitute prefix TVF in place of TVA. Frames will include trim and 2 pairs of tapped panel mounting angles.

Trim Numbers

Added as suffix to assembly number. Includes vertical and horizontal members with vinyl inlay, complete and installed on frame.

5/8 Inch Vertical Trim Width	Horizontal 2 1/8 Inch*		Horizontal 3 Inch	
	Black Vinyl -2B	Walnut Vinyl -2W	Black Vinyl -3B	Walnut Vinyl -3W

*2 1/8 Inch must be specified for front door installation.

Side Panels (Supplied with TVA Series Assemblies)

Side panels are flush mounted, outside removable with recessed hand grip. Interchangeable left or right. Available louvered or slotted at additional cost.

Frame Vertical Panel Height (Inches)	Frame Panel-to-Panel Depth (Inches)		
	23	29	36
21	TVP-2123	TVP-2129	TVP-2136
31 1/2	TVP-3123	TVP-3129	TVP-3136
42	TVP-4223	TVP-4229	TVP-4236
52 1/2	TVP-5223	TVP-5229	TVP-5236
61 1/4	TVP-6123	TVP-6129	TVP-6136
70	TVP-7023	TVP-7029	TVP-7036
77	TVP-7723	TVP-7729	TVP-7736

Doors (Rear mounted door supplied with TVA Series assemblies)

Mounts left hand or right hand, front or rear with concealed hinges and is easily removable. Magnetic catches on closure side. Furnished with a recessed handle, lock and 2 keys.

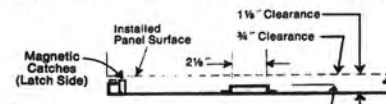

Note: Short door kit must be used when smaller door is being used. Catalog numbers SDK-19 for 19 inch or SDK-24 for 24 inch frames.

Frame Vertical Panel Height (Inches)	Frame Panel Width (Inches)		Plexiglas Frame Panel Width (Inches)	
	19	24	19	24
21	TVD-2119	TVD-2124	TVD-P-2119	TVD-P-2124
31 1/2	TVD-3119	TVD-3124	TVD-P-3119	TVD-P-3124
42	TVD-4219	TVD-4224	TVD-P-4219	TVD-P-4224
52 1/2	TVD-5219	TVD-5224	TVD-P-5219	TVD-P-5224
61 1/4	TVD-6119	TVD-6124	TVD-P-6119	TVD-P-6124
70	TVD-7019	TVD-7024	TVD-P-7019	TVD-P-7024
77	TVD-7719	TVD-7724	TVD-P-7719	TVD-P-7724

Note: For use as front door, specify 2 1/8 inch trim on assembly model and modification No. 017

Plexiglas Doors (For use as front door, specify 2 1/8 inch trim on frame)

1/4 inch thick plexiglas front surface permits viewing of instrumentation through closed door, retaining all the features of the standard trimline door, such as: quick release hinges, magnetic closure, keyed lock and flush handle. Smoke Gray is standard. Other colors available.



SVA-Vertical Assemblies

The Spartan Series offers all the basic requirements for housing electronic systems in a rugged, economical package designed with simple, clean lines. The Spartan Series incorporates, as standard, provisions for mounting electronic equipment and accessories required in the majority of systems packaging. Standard modifications are readily available to customize enclosure packaging for your complete needs.

Finished in all standard Premier colors shown on page 24. If not specified, Smoke Blue Textured will be furnished.

30° and 45° matching wedge frames are available for multiple bay console configurations. (See Page 12)

SVA Series Vertical Assembly: Construction Details

(1 frame, 2 end panels, rear door)
All features shown are standard in the Spartan SVA Series. Welded, formed steel construction.

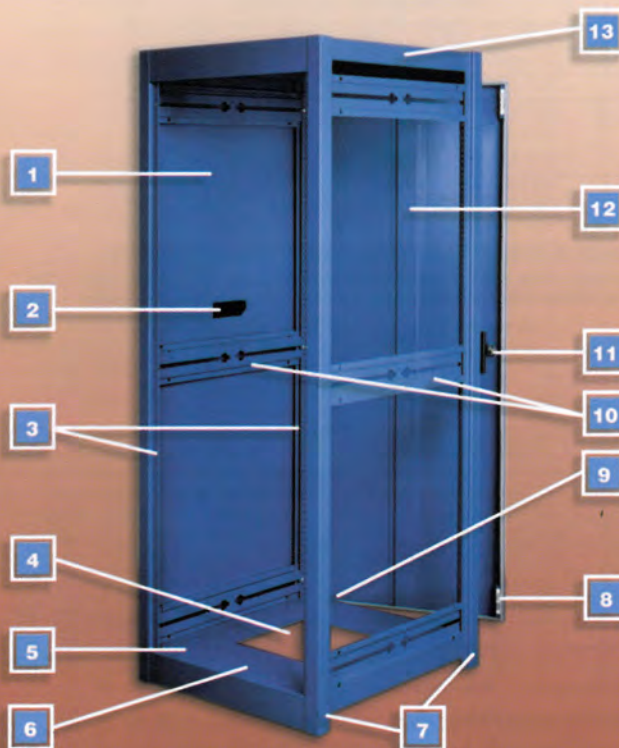

- 1** Outside removable flush end panels (18 gauge)
- 2** Recessed hand grip for panel removal
- 3** 2 pairs of panel mounting angles, fully adjustable front-to-rear with tapped 10-32 holes on EIA Standard spacing (12 gauge plated)
- 4** 10 x 10 inch cut-out for cable entry beneath base (optional)
- 5** Recessed caster mounting holes
- 6** 1 piece formed steel base provides for heavy equipment mounting area and concealed caster mounting (14 gauge)
- 7** Formed steel uprights (14 gauge) provide 1/2 inch recess to panel mounting angles
- 8** Magnetic closure
- 9** Quick release, spring loaded door hinges (top and bottom)
- 10** Horizontal cross-brace and panel mounting angle supports
- 11** Keyed latch and recessed pull handle
- 12** Door stiffener channel
- 13** 1 piece solid top for extra rigidity and squareness (14 gauge)

Vertical Enclosures

Basic Nominal Sizes

FRONT VIEW

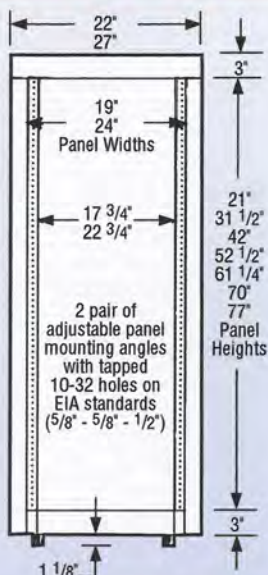

SIDE VIEW

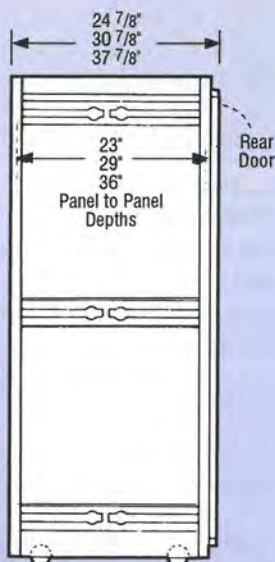

ORDERING INSTRUCTIONS

Select basic requirements for frame height, width and depth in the dimensional drawings; then select the assembly model number from the tables, which will include the frame, 2 side panels, rear door, specified color finish, assembled in 1 unit.

Modifications and accessories may be ordered as required.

Ordering Information

Assemblies

Assemblies include frame with 2 pairs of adjustable panel mounting angles (tapped with 10-32 holes on EIA spacing); 2 outside removable side panels; rear mounted door with handle, lock and 2 keys. Unit will be finished and assembled. Specify colors. (Door hinged right will be furnished unless otherwise specified.)

Vertical Panel Height (Inches)	19 Inch Panel Width Panel-to-Panel Depth (Inches)		
	23	29	36
21	SVA-2119-23	SVA-2119-29	SVA-2119-36
31 1/2	SVA-3119-23	SVA-3119-29	SVA-3119-36
42	SVA-4219-23	SVA-4219-29	SVA-4219-36
52 1/2	SVA-5219-23	SVA-5219-29	SVA-5219-36
61 1/4	SVA-6119-23	SVA-6119-29	SVA-6119-36
70	SVA-7019-23	SVA-7019-29	SVA-7019-36
77	SVA-7719-23	SVA-7719-29	SVA-7719-36
	24 Inch Panel Width		
21	SVA-2124-23	SVA-2124-29	SVA-2124-36
31 1/2	SVA-3124-23	SVA-3124-29	SVA-3124-36
42	SVA-4224-23	SVA-4224-29	SVA-4224-36
52 1/2	SVA-5224-23	SVA-5224-29	SVA-5224-36
61 1/4	SVA-6124-23	SVA-6124-29	SVA-6124-36
70	SVA-7024-23	SVA-7024-29	SVA-7024-36
77	SVA-7724-23	SVA-7724-29	SVA-7724-36

To order frames only, substitute prefix SVF in place of SVA. Frames will include 2 pairs of tapped panel mounting angles.

Side Panels: Supplied with SVA Series Assemblies

Side panels are flush mounted, outside removable with recessed hand grip. Interchangeable left or right. Available louvered or slotted at additional cost.

Frame Vertical Panel Height (Inches)	Frame Panel-to-Panel Depth (Inches)		
	23	29	36
21	TVP-2123	TVP-2129	TVP-2136
31 1/2	TVP-3123	TVP-3129	TVP-3136
42	TVP-4223	TVP-4229	TVP-4236
52 1/2	TVP-5223	TVP-5229	TVP-5236
61 1/4	TVP-6123	TVP-6129	TVP-6136
70	TVP-7023	TVP-7029	TVP-7036
77	TVP-7723	TVP-7729	TVP-7736

Doors: Rear mounted door supplied with SVA Series assemblies

Mounts left hand or right hand, front or rear with concealed hinges and is easily removable. Magnetic closure. Furnished with a recessed handle, lock and 2 keys. Note: Short door kit must be used when smaller door is being used. Catalog numbers SDK-19 for 19 Inch or SDK-24 for 24 Inch frames.

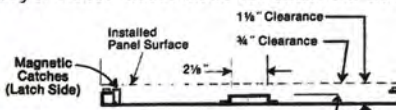

Frame Vertical Panel Height (Inches)	Frame Panel Width (Inches)		Plexiglas Frame Panel Width (Inches)	
	19	24	19	24
21	TVD-2119	TVD-2124	TVD-P-2119	TVD-P-2124
31 1/2	TVD-3119	TVD-3124	TVD-P-3119	TVD-P-3124
42	TVD-4219	TVD-4224	TVD-P-4219	TVD-P-4224
52 1/2	TVD-5219	TVD-5224	TVD-P-5219	TVD-P-5224
61 1/4	TVD-6119	TVD-6124	TVD-P-6119	TVD-P-6124
70	TVD-7019	TVD-7024	TVD-P-7019	TVD-P-7024
77	TVD-7719	TVD-7724	TVD-P-7719	TVD-P-7724

Plexiglas Doors

1/4 inch thick plexiglas front surface permits viewing of instrumentation through closed door, retaining all the features of the standard door, such as: quick release hinges, magnetic closure, keyed lock and flush handle. Smoke Gray standard. Other colors available.

Trimline TSA Series — Sloped Front Panel Enclosures

30° and 45° matching wedge frames are available for multiple bay console configurations - see page 12

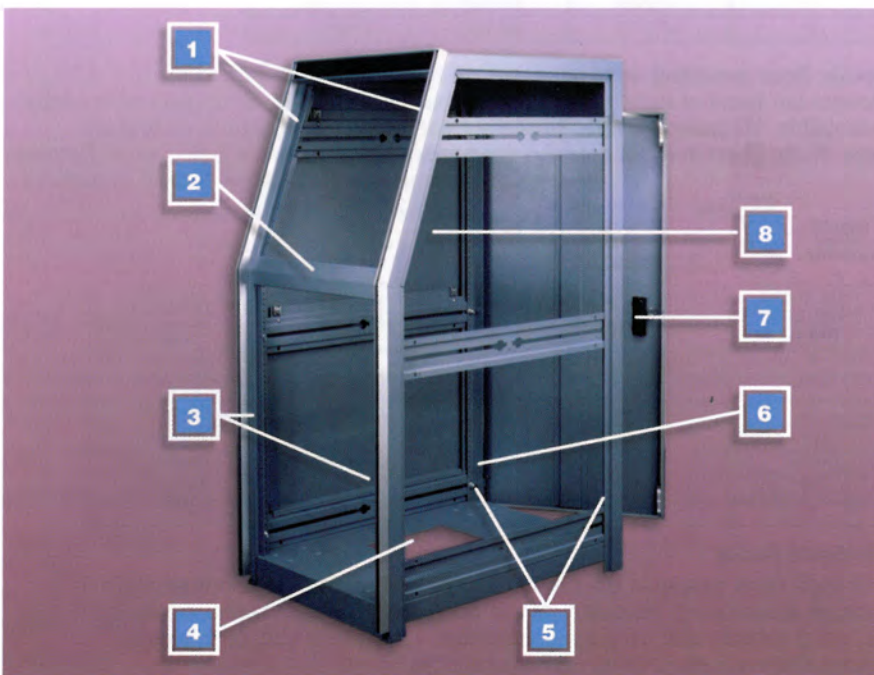

TSA Series — Sloped Front Panel Assembly

Assemblies include 1 frame, 2 end panels, and rear door. General construction details are the same as the vertical assemblies.

- 1** Fixed front sloped panel mounting angles with tapped 10-32 EIA standard spacing
- 2** Removable front cross piece
- 3** Lower front panel mounting angles adjustable front to rear
- 4** 10" x 10" cut-out for cable entry beneath base (optional)
- 5** Rear panel mounting angles adjustable rear to front
- 6** Quick release door hinge pins, spring loaded — top and bottom
- 7** All door features are the same as the vertical assembly door construction
- 8** Outside removable end panels

Sloped Front Enclosures

Basic Nominal Sizes

19 - 17 1/2" SLOPED PANEL

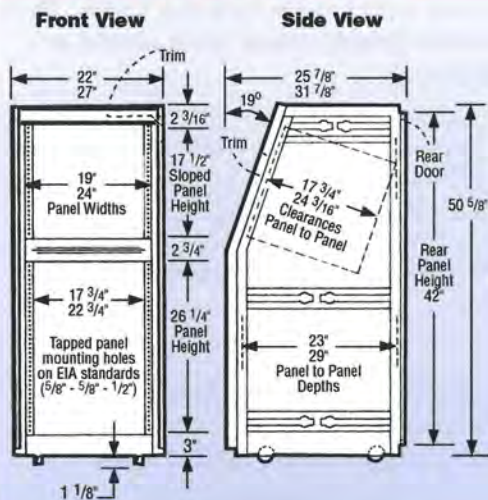

ORDERING INFORMATION

Select basic requirements for sloping panel height, width and depth in the dimensional drawings, then select the assembly model number from the tables which will include the frame, 1 pair of side panels, rear door, specified trim and color finish — assembled in 1 unit.

Modifications and accessories may be ordered as required.

Ordering Information

Assemblies: Sloped Front Panel Racks

Assemblies include frame with trim and 2 pairs of adjustable vertical panel mounting angles (tapped with 10-32 holes on EIA spacing) and fixed angles on the front sloping panel area; 2 outside removable side panels; rear mounted door with handle, lock and 2 keys. Units will be finished and assembled. Specify colors and trim combination. (Door hinged at right unless otherwise specified.)

Sloped Panel Height (Inches)	19 Inch Panel Width Panel-to-Panel Depth (Vertical)		24 Inch Panel Width Panel-to-Panel Depth (Vertical)	
	23 Inches	29 Inches	23 Inches	29 Inches
17 1/2	TSA-1719-23	TSA-1719-29	TSA-1724-23	TSA-1724-29

To order frames only, substitute prefix TSF in place of TSA. Frames will include trim with 2 pairs of tapped panel mounting angles.

Trim

The trim is mounted flush with the front outline of the frame. The top horizontal section is 2 1/8 inches wide, covering the face of the frame top. The vertical sections are 5/8 inch wide, mitered at the slope break. To order desired style, add suffix to the assembly number.

- 2B for Black grained inlay
- 2W for Walnut, textured inlay (see illustration on page 6)

Side Panels: Supplied with TSA Series Assemblies

The side panels are outside removable.

The model number designates a pair (1 each, left and right).

Sloped Panel Height (Inches)	Vertical Panel-to-Panel Depth	
	23 Inches	29 Inches
17 1/2	TSP-1723	TSP-1729

Rear Door: Supplied with TSA Series Assemblies

Door mounts left hand or right hand with concealed hinges and is instantly removable. Magnetic closure and furnished with a recessed handle, lock and 2 keys.

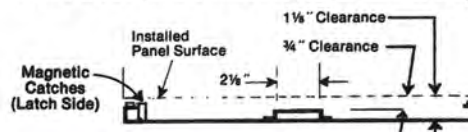

Rear Panel Height (Inches)	Frame Panel Width	
	19 Inches	24 Inches
42	TVD-4219	TVD-4224

Note: Short door kit must be used when smaller door is being utilized. Catalog numbers SDK-19 for 19 inches or SDK-24 for 24-inch frames.

Front Doors

Doors for the front vertical panel opening are available. These doors mount onto the panel mounting angles. (See CD Series, page 18.)

Sloped Front Enclosures

Basic Nominal Sizes



19-17 1/2" SLOPED PANEL

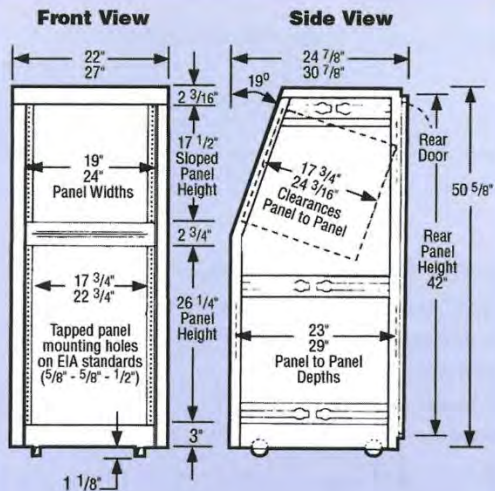

ORDERING INSTRUCTIONS

Select basic requirements for sloping panel height, width and depth in the dimensional drawings, then select the assembly model number from the tables which will include the frame, 1 pair of side panels, rear door, specified trim and color finish — assembled in 1 unit.

Modifications and accessories may be ordered as required.

Ordering Information

Assemblies: Sloped Front Panel Racks

Assemblies include frame and 2 pairs of adjustable vertical panel mounting angles (tapped with 10-32 holes on EIA spacing) and fixed angles on the front sloping panel area; 2 outside removable side panels; rear mounted door with handle, lock and 2 keys. Units will be finished and assembled. Specify colors. (Door hinged at right unless otherwise specified.)

Sloped Panel Height (Inches)	19 Inch Panel Width Panel-to-Panel Depth (Vertical)		24 Inch Panel Width Panel-to-Panel Depth (Vertical)	
	23 Inches	29 Inches	23 Inches	29 Inches
17 1/2	SSA-1719-23	SSA-1719-29	SSA-1724-23	SSA-1724-29

To order frames only, substitute prefix SSF in place of SSA. Frames will include trim with 2 pairs of tapped panel mounting angles.

Side Panels: Supplied with SSA Series Assemblies

The side panels are outside removable.

The model number designates a pair (1 each, left and right).

Sloped Panel Height (Inches)	Vertical Panel-to-Panel Depth	
	23 Inches	29 Inches
17 1/2	TSP-1723	TSP-1729

Rear Door: Supplied with SSA Series Assemblies

Door mounts left hand or right hand with concealed hinges and is instantly removable. Magnetic closure and furnished with a recessed handle, lock and 2 keys.

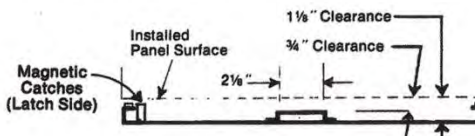

Note: Short door kit must be used when smaller door is being utilized. Catalog numbers SDK-19 for 19 inches or SDK-24 for 24-inch frames.

Rear Panel Height (Inches)	Frame Panel Width	
	19 Inches	24 Inches
42	TVD-4219	TVD-4224

Front Doors

Doors for the front vertical panel opening are available. These doors mount onto the panel mounting angles. (See CD Series, page 18.)

Trimline and Spartan Series Wedges



Wedge Frames — 30° and 45° (For Use With Vertical & Sloped Series)

Wedge frames are designed to enable the construction of console stations in variable bayed configurations using standard modular units. Single piece or multiple piece work table units are available for any configuration specified to form a unitized console. With the utilization of casters, consoles may be made into moveable stations.

Construction

Wedge frames are welded steel with one-piece bottom and top. Full size removable rear panels are included. Ganging kits (CGK-6) are available for adjacent bays.

Ordering Information

Wedge Frames for Sloped Front Panel Units: Trimline and Spartan Series

Sloped Panel Height (Inches)	Panel-to-Panel Depth (Inches)	30° Units Catalog No.	45° Units Catalog No.
17 1/2	23	WTS-30-1723	WTS-45-1723
17 1/2	29	WTS-30-1729	WTS-45-1729

Wedge Frame for Vertical Units: Trimline and Spartan Series

Match panel-to-panel depth and vertical panel heights to adjacent cabinets in angle desired (30° or 45°)

Vertical Panel Height (Inches)	30° Units — Panel-to-Panel Depth (Inches)		
	23	29	36
21	WTV-30-2123	WTV-30-2129	WTV-30-2136
31 1/2	WTV-30-3123	WTV-30-3129	WTV-30-3136
42	WTV-30-4223	WTV-30-4229	WTV-30-4236
52 1/2	WTV-30-5223	WTV-30-5229	WTV-30-5236
61 1/4	WTV-30-6123	WTV-30-6129	WTV-30-6136
70	WTV-30-7023	WTV-30-7029	WTV-30-7036
77	WTV-30-7723	WTV-30-7729	WTV-30-7736
	45° Units — Panel-to-Panel Depth (Inches)		
	23	29	36
21	WTV-45-2123	WTV-45-2129	WTV-45-2136
31 1/2	WTV-45-3123	WTV-45-3129	WTV-45-3136
42	WTV-45-4223	WTV-45-4229	WTV-45-4236
52 1/2	WTV-45-5223	WTV-45-5229	WTV-45-5236
61 1/4	WTV-45-6123	WTV-45-6129	WTV-45-6136
70	WTV-45-7023	WTV-45-7029	WTV-45-7036
77	WTV-45-7723	WTV-45-7729	WTV-45-7736

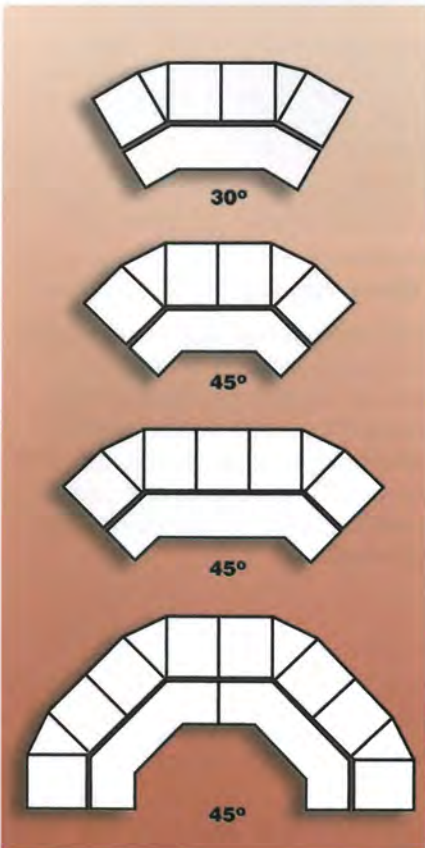

Multiple Bay Writing Surface with Use of Wedge Frame

Curved consoles using wedge frames can be made in "U" shapes or "L" shapes to accommodate available space and human engineering requirements. Writing surfaces may or may not be needed for specific applications. We suggest that rough sketches (as illustrated on the left), outlining your general specifications, be submitted to our Engineering Department for exact dimensioning, estimating and possible suggestions to meet your specific needs in the most economical manner.



LAN Management System Enclosures

These beautifully styled cabinets are designed to address all your digital communication network housing needs. They come in both single and double width versions with the best feature-to-price ratio available anywhere ...

- Large cable entry cut-outs
 - Single: 12"W x 5"D
 - Double: 36"W x 6"D
- Cable management system available
- Bolt together for multiple bay configurations
- Double vented rear doors for extra ventilation
- Lift-off sides for total accessibility
- Smart looking smoked Plexiglas front doors
- Single cabinets are equipped with drilled and 10-32 tapped angles for easy equipment installation
- Many accessories are available — see pages 16 through 23 for details

What You Get As A Standard

LAN cabinets are shipped complete, and include frame, lift off side panels, vented rear door (double doors come with double width cabinet), plexiglas front doors, and tapped EIA spaced angles (single width cabinet 19" horizontal panel opening).

Ordering Information

Order LAN components separately as follows:

Item	Part Number	
	Single Width Cabinet	Double Width Cabinet
Frame	LAF-832430	LAF-834830
Side Panel	LAP-8330	
Vented Rear Door	LAD-7719	LAD-8324*
Plexiglas Front Door	LAD-P-7719	LAD-P-8324*
Stationary Shelf	RSH-1926	LSH-4826**
Sliding Shelf	RSS-1926***	LSS-4826****
Keyboard Shelf	RSK-1926***	LSK-4826****

- * Sold in sets of two each only
- ** Shelf is vented and is 41⁷/₁₆" W x 25¹⁵/₃₂" D
- *** Must be ordered with SBB-100-26 slide
- **** Double width shelves include slides

Accessories

See pages 16 through 23 for accessories such as outlet strips, fans, casters, leveling legs, etc.

Dimensions

Overall single width cabinet	83 ¹ / ₈ " H x 24" W x 30" D
Overall double width cabinet	83 ¹ / ₈ " H x 48" W x 30" D
Single width inside opening	77" H x 19" W x 29" D
Double width inside opening	77" H x 43 ¹ / ₁₆ " W x 29" D

LAN Management System Enclosures Can Be Ordered In A Frame Version (Without Doors)





MaxiFlow Series FSA Network Server Cabinets

Premier MaxiFlow Series FSA slotted door cabinets are designed to house 19-inch rack-mounted servers, as well as tower configured systems. Plexiglas front door with slots, a perforated steel rear door and a perforated top panel assure maximum airflow. Fans or blowers can be added. Side panels easily lift off for component accessibility and cabinet ganging.

Series FSA cabinets include a frame with two pairs of adjustable panel mounting angles (tapped 10-32 or with provisions for 6 mm cage nuts.) Specify type of panel mounting angles required when ordering 10-32 or 6 mm.

Example: FSA-7319-29-10-32 or 6 mm

Casters make this cabinet easily movable, and even the tallest model fits under most door heights. Anti-tipping devices are available for increased stability. Door locks ensure equipment protection.

Models are available in a range of sizes. Heights are 73-1/2 inches (42 U) or 77 inches (44 U.) 19-inch panel widths are available with depths of 29 and 36 inches.

Premier MaxiFlow Series FSA cabinets are supported by a full range of accessories.

Model Panel Height (Inches)	19" Panel Width	
	29" Panel to Panel Depth	36" Panel to Panel Depth
73 1/2	FSA-7319-29	FSA-7319-36
77	FSA-7719-29	FSA-7719-36

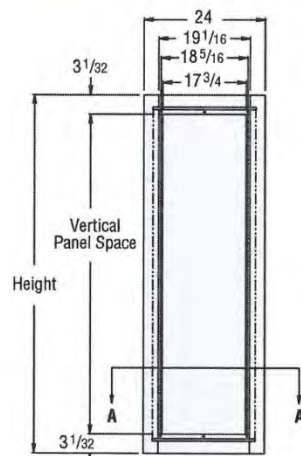

Front View

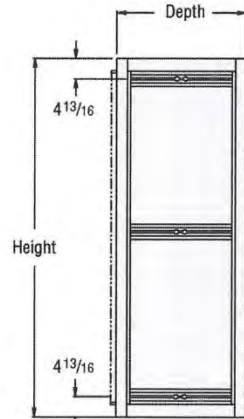

Side View

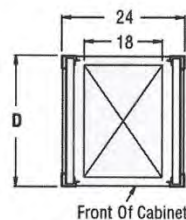
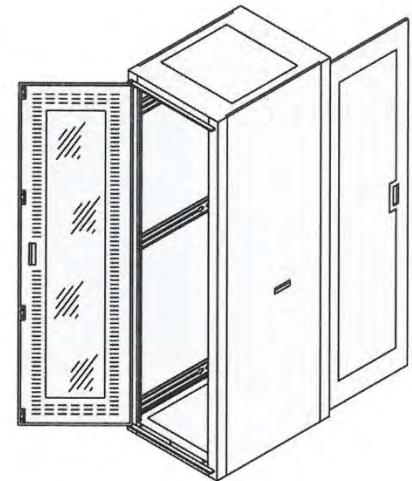

View Sec. A-A

Model Number	Height (Inches)	Depth (Inches)	V.P. Space (Inches)	H.P. Space (Inches)
FSA-7319-29	79 5/8	30	73 9/16	19 1/16
FSA-7719-29	83 1/8	30	77 1/16	19 1/16
FSA-7319-36	79 5/8	37	73 9/16	19 1/16
FSA-7719-36	83 1/8	37	77 1/16	19 1/16

Choose From An Extensive Range Of Accessories

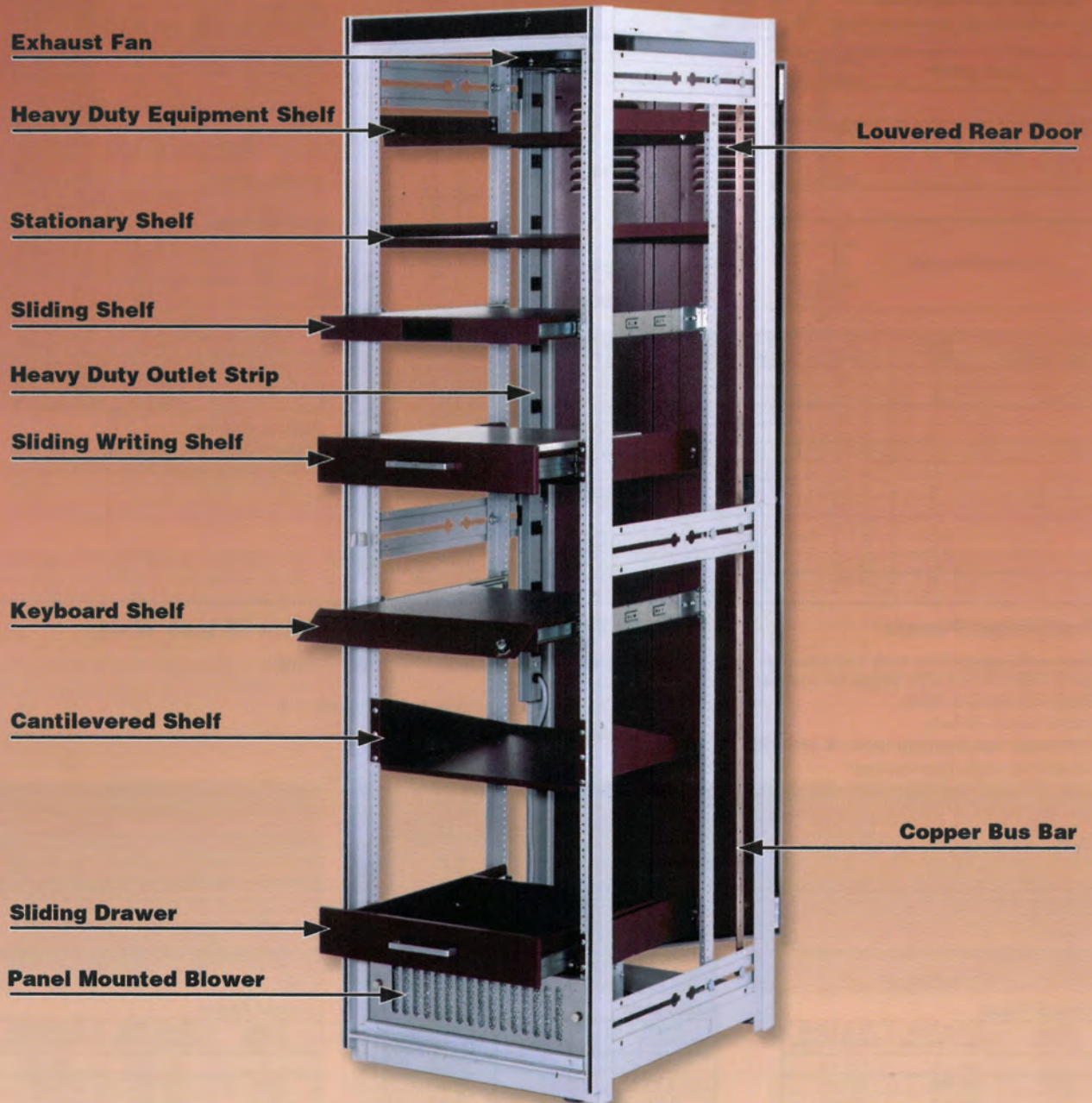

More Accessories Offered...

- Plexiglas & Metal Doors
- Exhaust Fans
- Casters
- Anti-Tip Devices
- Blank Panels
- Ventilated Panels
- Eye Bolts
- Turrets
- Switch Turrets
- Formica Writing Surfaces
- Panel Handles

Standard Panel Layout For All PREMIER Panels

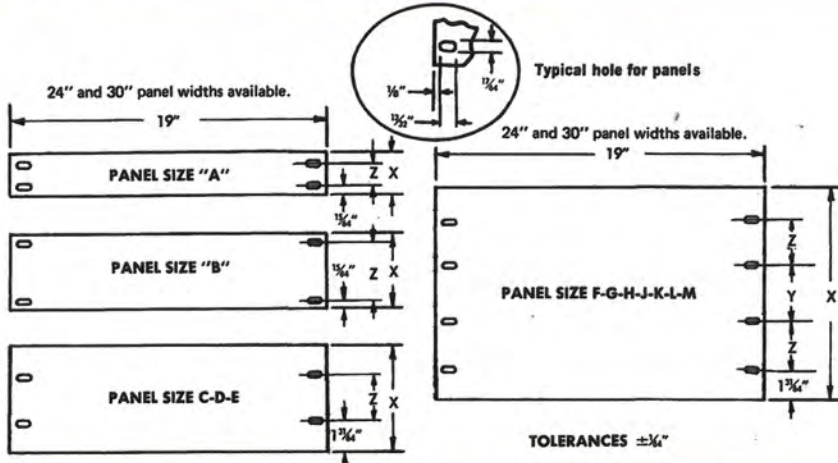

Number of 1 3/4 Inch Mounting Units	Panel Size	X (Inches)	Y (Inches)	Z (Inches)	No. of Slots Each Side	Catalog Number
1	A	1 23/32		1 1/4	2	MAP, ARP and RP-119
2	B	3 15/32		3	2	MAP, ARP and RP-319
3	C	5 7/32		2 1/4	2	MAP, ARP and RP-519
4	D	6 31/32		4	2	MAP, ARP and RP-719
5	E	8 23/32		5 3/4	2	MAP, ARP and RP-819
6	F	10 15/32	3	2 1/4	4	MAP, ARP and RP-1019
7	G	12 7/32	2 1/4	3 1/2	4	MAP, ARP and RP-1219
8	H	13 31/32	3	4	4	MAP, ARP and RP-1419
9	J	15 23/32	4 3/4	4	4	MAP, ARP and RP-1519
10	K	17 15/32	6 1/2	4	4	MAP, ARP and RP-1719
11	L	19 7/32	5 3/4	5 1/4	4	MAP, ARP and RP-1919
12	M	20 31/32	7 1/2	5 1/4	4	MAP, ARP and RP-2119

Panel Mounting Angles

1 1/4 x 1 1/4 Inches

Made of 12 gauge (.104) thick steel punched on EIA spacings (5/8 - 5/8 - 1/2 inches) on both legs, with 9/32 inch clearance holes (for panel mounting hardware, see HW-14). Angles with tapped holes available.

Specify PMAT plus number.

Mounting Angles

Height (Inches)	Catalog Number
21	PMA-212
26 1/4	PMA-262
28	PMA-282
31 1/2	PMA-312
36 3/4	PMA-362
42	PMA-422
52 1/2	PMA-522
61 1/4	PMA-612
70	PMA-702
77	PMA-772

Also available:

Extra wide panel mounting angles to reduce panel space from 24" to 23" or 19".

Perforated Panels

- Made of 20-gauge steel with 1/16 inch diameter holes on 3/16 inch staggered centers
- Edges formed on 4 sides
- Overall depth 1/2 inch
- Each panel has mounting holes on each side
- Finished in Light Gray enamel



Formed Panels: 1/2 Inch Deep, 19 and 24 Inch Wide

- Made of 1 piece, 16-gauge steel with edges formed for overall depth of 1/2 inch
- Each panel has only 2 mounting holes on each side
- Finished in Light Gray enamel



Perforated Panels

Height (Inches)	19 Inch Wide Catalog Number	24 Inch Wide Catalog Number
1 3/4	PFP-119	PFP-124
3 1/2	PFP-319	PFP-324
5 1/4	PFP-519	PFP-524
7	PFP-719	PFP-724
8 3/4	PFP-819	PFP-824
10 1/2	PFP-1019	PFP-1024
12 1/4	PFP-1219	PFP-1224
14	PFP-1419	PFP-1424
15 3/4	PFP-1519	PFP-1524
17 1/2	PFP-1719	
19 1/4	PFP-1919	
21	PFP-2119	
26 1/4	PFP-2619	
28	PFP-2819	

Blank Panels

Height (Inches)	19 Inch Wide Catalog Number	24 Inch Wide Catalog Number
1 3/4	FP-119	FP-124
3 1/2	FP-319	FP-324
5 1/4	FP-519	FP-524
7	FP-719	FP-724
8 3/4	FP-819	FP-824
10 1/2	FP-1019	FP-1024
12 1/4	FP-1219	FP-1224
14	FP-1419	FP-1424
15 3/4	FP-1519	FP-1524
17 1/2	FP-1719	FP-1724
19 1/4	FP-1919	FP-1924
21	FP-2119	FP-2124
22 3/4	FP-2219	FP-2224
26 1/4	FP-2619	FP-2624
28	FP-2819	FP-2824

Louvered Panels

Height (Inches)	19 Inch Wide Catalog Number	24 Inch Wide Catalog Number
7	FPL-719	FPL-724
8 3/4	FPL-819	FPL-824
10 1/2	FPL-1019	FPL-1024
12 1/4	FPL-1219	FPL-1224
14	FPL-1419	FPL-1424
17 1/2	FPL-1719	FPL-1724
21	FPL-2119	FPL-2124
22 3/4	FPL-2219	FPL-2224
26 1/4	FPL-2619	FPL-2624
28	FPL-2819	FPL-2824
42	FPL-4219	FPL-4224

Masked Aluminum Panels

19 Inches Wide

Nominal Height (Inches)	1/8 Inch Thick Aluminum Catalog Number	3/16 Inch Thick Aluminum Catalog Number
1 3/4	MAP-119	MAP-119-36
3 1/2	MAP-319	MAP-319-36
5 1/4	MAP-519	MAP-519-36
7	MAP-719	MAP-719-36
8 3/4	MAP-819	MAP-819-36
10 1/2	MAP-1019	MAP-1019-36
12 1/4	MAP-1219	MAP-1219-36
14	MAP-1419	MAP-1419-36
15 3/4	MAP-1519	MAP-1519-36
17 1/2	MAP-1719	MAP-1719-36
19 1/4	MAP-1919	MAP-1919-36
21	MAP-2119	MAP-2119-36
26 1/4	MAP-2619	MAP-2619-36
31 1/2	MAP-3119	MAP-3119-36
35	MAP-3519	MAP-3519-36

Writing Shelves for Trimline & Spartan Series

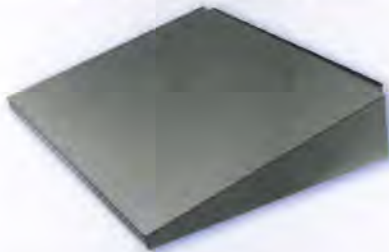

White Formica-covered particle board mounts over welded support bracket(s) and panel assembly. Unit mounts to standard 5 1/4 inch panel space. These shelves can be used when frames are mounted in a straight line, *without* the use of wedge frames.

Frame Width (Inches)	Shelf Dimensions Width x Depth (Inches)	Catalog Number
1 Bay 19	20 5/8 x 18 1/2	TWS-1918
2 Bay 19	42 5/8 x 18 1/2	TWS-3818
3 Bay 19	64 5/8 x 18 1/2	TWS-5718
4 Bay 19	86 5/8 x 18 1/2	TWS-7618
1 Bay 24	25 5/8 x 18 1/2	TWS-2418
2 Bay 24	52 5/8 x 18 1/2	TWS-4818
3 Bay 24	79 5/8 x 18 1/2	TWS-7218
4 Bay 24	86 5/8 x 18 1/2	TWS-9618

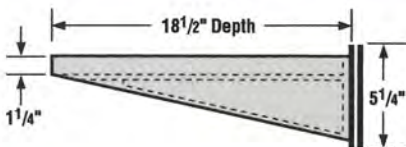

Blank Rack Panels — 9 1/2, 19, 23 and 24 Inch Widths

Premier Blank Panels are available in either aluminum or steel. All panels have closed slots for rigidity with spacing according to EIA standards. Open slots available on special order. Note that all panels are cut 1/32 inch less than nominal height indicated in ordering tables. Panels are finished in Light Gray. Other colors are available at additional cost.

Masked Aluminum Panels are made of bright natural aluminum covered on both sides with special self-adhesive paper. Drilling or milling can be done on paper in place, affording complete damage protection.

Modifications are available, including unfinished, special finishes and special heights.

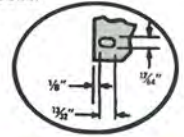

Aluminum & Steel Panels

24 Inches Wide

Nominal Height (Inches)	1/8 Inch Thick Aluminum Catalog Number	12-Gauge Steel Catalog Number
1 3/4	ARP-124	RP-124
3 1/2	ARP-324	RP-324
5 1/4	ARP-524	RP-524
7	ARP-724	RP-724
8 3/4	ARP-824	RP-824
10 1/2	ARP-1024	RP-1024
12 1/4	ARP-1224	RP-1224
14	ARP-1424	RP-1424
15 3/4	ARP-1524	RP-1524
17 1/2	ARP-1724	RP-1724
19 1/4	ARP-1924	RP-1924
21	ARP-2124	RP-2124

Grille Panels

Nominal Height* (Inches)	Grille Size (Inches)	Catalog Number
5 1/4	3 7/8 x 13 3/8	GRP-601
7	3 7/8 x 13 3/8	GRP-602
8 3/4	5 7/8 x 13 3/8	GRP-603
8 3/4	3 7/8 x 13 3/8*	GRP-604
10 1/2	7 7/8 x 13 3/8	GRP-605
10 1/2	5 7/8 x 13 3/8*	GRP-606
12 1/4	7 7/8 x 13 3/8*	GRP-607

* Allows 3 1/2 inch space at bottom for chassis mounting



Side Hinged Door Panels



These panels are finished in Light Gray and manufactured in 12-gauge steel. They can be used for left or right hand opening.

Height (Inches)	Catalog Number
3 1/2	SHP-319
5 1/4	SHP-519
7	SHP-719
8 3/4	SHP-819
10 1/2	SHP-1019
12 1/4	SHP-1219
14	SHP-1419
21	SHP-2119

Supplied with a quick turn fastener. Full height piano hinge welded to panel. Cylinder lock (HW-6) available at additional cost.

Painted Aluminum & Steel Panels

19 Inches Wide

Nominal Height (Inches)	1/8 Inch Thick Aluminum Catalog No.	3/16 Inch Thick Aluminum Catalog No.	12-Gauge Steel Catalog No.
1 3/4	ARP-119	ARP-119-36	RP-119
3 1/2	ARP-319	ARP-319-36	RP-319
5 1/4	ARP-519	ARP-519-36	RP-519
7	ARP-719	ARP-719-36	RP-719
8 3/4	ARP-819	ARP-819-36	RP-819
10 1/2	ARP-1019	ARP-1019-36	RP-1019
12 1/4	ARP-1219	ARP-1219-36	RP-1219
14	ARP-1419	ARP-1419-36	RP-1419
15 3/4	ARP-1519	ARP-1519-36	RP-1519
17 1/2	ARP-1719	ARP-1719-36	RP-1719
19 1/4	ARP-1919	ARP-1919-36	RP-1919
21	ARP-2119	ARP-2119-36	RP-2119
26 1/4	ARP-2619	ARP-2619-36	RP-2619
31 1/2	ARP-3119	ARP-3119-36	RP-3119
35	ARP-3519	ARP-3519-36	RP-3519

Flush Mounted Door

1/2 Inch Deep

16-gauge steel, 1 piece construction. May be mounted left or right. Supplied with recessed handle and snap catch. Doors mount onto panel mounting angles.

Width (Inches)	Height (Inches)	Catalog Number
19	17 1/2	CD-17
19	21	CD-21
19	26 1/4	CD-26
19	28	CD-28
19	29 3/4	CD-29
19	42	CD-42
24	17 1/2	CD-1724
24	21	CD-2124
24	26 1/4	CD-2624
24	28	CD-2824
24	29 3/4	CD-2924
24	42	CD-4224



Chassis Support Angles and Shelves

Standard Series

These plated support angles are manufactured in 12-gauge steel and are designed to support TES Series shelves. They mount to side legs of panel mounting angles.



Shelf and Chassis support angles in position.

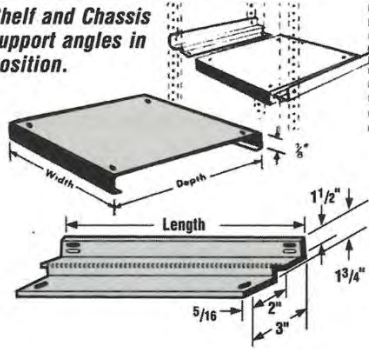

Equipment Shelves

Rack Panel Width (Inches)	Rack Panel-To-Panel Depth			
	17" Catalog Number	23" Catalog Number	26" Catalog Number	29" Catalog Number
19	TES-1917	TES-1923	TES-1926	TES-1929
24	TES-2417	TES-2423	TES-2426	TES-2429

Support Angles

Actual Length (Inches)	To Fit Panel-to-Panel Rack Depth (Inches)	Catalog Number
16 1/8	17	TCS-17
22 1/8	23	TCS-23
25 1/8	26	TCS-26
28 1/8	29	TCS-29

Note: Sold in pairs only.

Top Filler Panels

Used to fill top opening between top ganged frames if side panels are omitted.

For Panel-to-Panel Frame Depth (Inches)	Use Filler Panel Catalog Number
17	TFP-17
23	TFP-23
26	TFP-26
29	TFP-29



FOLD-UP KEYBOARD SHELF
RFK - 19
RFK - 23
RFK - 24

Leveling Legs

Trimline and Spartan Series

Rubber cushioned, swivel base levelers are non-marking, non-skid and absorb vibration. Cushions are 1 1/2 inch diameter and 5/8 inch thick. Adjusting stud is 1/2 - 1/4 inch thread. Set of four (4) is supplied with mounting brackets and all necessary hardware to mount under Trimline or Spartan Base. Tested to 250 lbs. per leg.

Catalog Number: TLL-250 (set of 4)

Sliding Drawers

Welded, steel drawers are cradle mounted on full extension roller bearing slides with a disconnect feature. The suspension cradle mounts to the front panel mounting angles.



Sliding Shelves

Formica covered sliding shelves mount into cradle on full extension roller bearing slides with a disconnect feature. The cradle mounts to the front panel mounting angles. Shelves use 3 1/2 inch panel height.



Anti-Tipping Device

These pairs of extension bars mount to full depth of cabinet, extending one foot in front of cabinet to prevent tipping.

Note: Cannot be used without casters (Catalog No. CA-5). Should be ordered with cabinet.

Panel-to-Panel Rack Depth (Inches)	Catalog Number
23	ATD-23
29	ATD-29
36	ATD-36



Front Panel Size		Drawer Dimensions			Catalog Number
Height (Inches)	Width (Inches)	Height (Inches)	Width (Inches)	Depth (Inches)	
3 1/2	19	2 11/16	16 1/8	16	TDR-319
7	19	6	16 1/8	16	TDR-719
10 1/2*	19	6	16 1/8	16	TDR-1019
3 1/2	24	2 11/16	21 1/8	16	TDR-324
7	24	6	21 1/8	16	TDR-724
10 1/2*	24	6	21 1/8	16	TDR-1024

* Keyed cam lock available on 10 1/2 inch panel sizes

Front Panel Size		Shelf Size		Catalog Number
Height (Inches)	Width (Inches)	Width (Inches)	Depth (Inches)	
3 1/2	19	16 3/16	15 19/16	TWS-319
3 1/2	24	21 3/16	15 15/16	TWS-324

Ganging Kits

For multi-bay and console units. All hardware supplied.

Catalog Number: CGK-6 for ganging each additional standard frame.



Sliding Keyboard Shelves

Constructed of 16-gauge steel with a 5 1/4 inch hinged front panel. Top panel is 3 1/2 inches and hinges down when keyboard is in use. Supplied with a cylinder lock for securing in the closed position.

For 19 Inch Panel Width			For 24 Inch Panel Width			Use Slide
Width (Inches)	Depth (Inches)	Catalog Number	Width (Inches)	Depth (Inches)	Catalog Number	Catalog Number
16 3/4	15 7/8	RSK-1917	21 3/4	15 7/8	RSK-2417	SBB-100-16
16 3/4	21 7/8	RSK-1923	21 3/4	21 7/8	RSK-2423	SBB-100-22
16 3/4	23 7/8	RSK-1926	21 3/4	23 7/8	RSK-2426	SBB-100-24
16 3/4	27 7/8	RSK-1929	21 3/4	27 7/8	RSK-2429	SBB-100-28

Note: Slides must be ordered separately.
Shorter shelves can be utilized by moving rear angles forward.

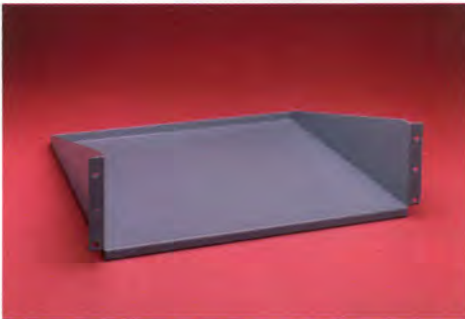

Cantilevered Shelves

Constructed of 16-gauge steel. Utilizes 5 1/4 inches of panel space for mounting to front panel mounting angles.

For 19 Inch Panel Width			For 24 Inch Panel Width		
Width (Inches)	Depth (Inches)	Catalog Number	Width (Inches)	Depth (Inches)	Catalog Number
17 1/2	16 1/2	RSC-1917	22 1/2	16 1/2	RSC-2417
17 1/2	20 1/2	RSC-1920	22 1/2	20 1/2	RSC-2420

Note: Slotted shelves available on special order — add S to Catalog Number
Example: RSC-1917-S



Stationary Shelves

Constructed of 16-gauge steel. Shelf mounts front and rear to inside leg of panel mounting angles.

For 19 Inch Panel Width			For 24 Inch Panel Width		
Width (Inches)	Depth (Inches)	Catalog Number	Width (Inches)	Depth (Inches)	Catalog Number
20	16 1/4	RSH-1917	25	16 1/4	RSH-2417
20	22 1/4	RSH-1923	25	22 1/4	RSH-2423
20	25 1/4	RSH-1926	25	25 1/4	RSH-2426
20	28 1/4	RSH-1929	25	28 1/4	RSH-2429

Note: Slotted shelves available — add S to Catalog Number
Example: RSH-1917-S
Shorter depth shelves can be utilized by moving rear angles forward.



Sliding Shelves

Constructed of 16-gauge steel. 1 3/4 inch front panel, flush pull, and supplied with all necessary mounting hardware.

For 19 Inch Panel Width			For 24 Inch Panel Width			Use Slide
Width (Inches)	Depth (Inches)	Catalog Number	Width (Inches)	Depth (Inches)	Catalog Number	Catalog Number
16 3/4	15 7/8	RSS-1917	21 3/4	15 7/8	RSS-2417	SBB-100-16
16 3/4	21 7/8	RSS-1923	21 3/4	21 7/8	RSS-2423	SBB-100-22
16 3/4	23 7/8	RSS-1926	21 3/4	23 7/8	RSS-2426	SBB-100-24
16 3/4	27 7/8	RSS-1929	21 3/4	27 7/8	RSS-2429	SBB-100-28

Note: Slides must be ordered separately.
Shorter shelves can be utilized by moving rear angles forward.

Extension Slides — Heavy Duty

- Quick disconnect (front, unhandled lever)
- High strength cold rolled steel
- Finish: Bright electro zinc
- Side space 1/2 inch (+1/16 -0)
- Height 1 13/16 inches
- Three telescoping members allow full accessibility for instant servicing
- Supplied with all necessary mounting hardware

Slide Length (Inches)	Travel Length (Inches)	Load Rating (Pounds)	Catalog Number
13 25/32	14.0	110	SBB-100-14
15 3/4	16.0	107	SBB-100-16
18	18.0	100	SBB-100-18
19 11/16	20.0	96	SBB-100-20
21 21/32	22.0	92	SBB-100-22
23 5/8	24.0	88	SBB-100-24
25 19/32	26.0	82	SBB-100-26
27 9/16	28.0	78	SBB-100-28



SBB-100-Series

Exhaust And Intake Fans

Exhaust and motor assemblies are shock mounted for minimum noise and vibration. Interchangeable accessories are available. Motors are shaded pole with permanently lubricated ball bearings, operating at 115 volts, 50 / 60 cycle, AC single phase with low temperature rise; supplied with 36 inch plug and cord.



Parameter	Catalog Number
	EF-550
CFM	550
Motor Watts	67
RPM	1650

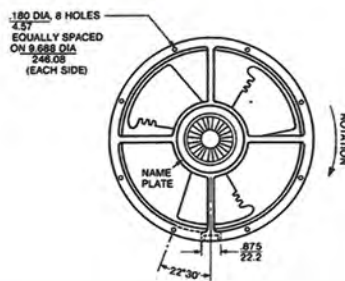
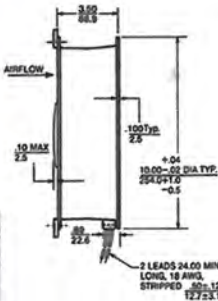

Panel Mounted Blowers

To Fit Standard 19" Wide Panel Space

These blowers provide maximum cooling with minimum space requirements at a low noise level with minimum vibration. Panel mounting provisions are for EIA standard 19 inch panel spacing. Permanently lubricated ball bearing motors with lubricant temperature range from -20°C to +148°C, operate on 115 volt, 50 / 60 cycle, AC, single phase current. Permanent type washable filter is easily removable from the front. Chrome plated grille is supplied with 2 captive thumb nuts. Performance data prepared by an impartial, independent testing laboratory is available on request.

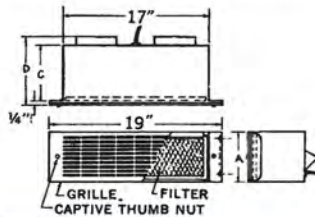

PMB Series
Units available to fit standard 24" wide panel space.

Parameter	Catalog Number				
	PMB-5-150	PMB-5-300	PMB-7-360	PMB-8-525	PMB-10-820
CFM at 0" S.P.	125	290	300	500	800
Panel Height (A, Inches)	5 1/4	5 1/4	7	8 3/4	10 1/2
Filter, Permanent (Inches)	16 5/8 x 4 7/8 x 1/2	16 5/8 x 4 7/8 x 1/2	16 5/8 x 6 3/4 x 1/2	16 5/8 x 8 1/2 x 1/2	16 5/8 x 10 1/8 x 1/2
Depth of Enclosure Only (C, Inches)	7 5/16	7 5/16	8 7/32	9	10 7/32
Overall Depth Including (D inches) Outlets	9 1/32	9 1/32	10 1/4	11 9/16	13 15/32
MOTOR					
RPM	3000	3050	1550	1700	1650
Watts	70	125	95	140	220
Volts	115	115	115	115	115
Cycles	50 / 60	50 / 60	50 / 60	50 / 60	50 / 50
AMPS	1.2	1.8	1.2	1.6	2.8
Type	Ball bearing shaded pole	Ball bearing shaded pole	Ball bearing shaded pole capacitor	Ball bearing permanent split capacitor	Ball bearing permanent split capacitor

Heavy Duty Outlet Strips — For Internal Rack Mounting

- Completely wired with circuit breaker — ready for use.
- Supplied with 6 foot Neoprene cord set with molded plug.
- Rated at 15 Amperes. 120 Volts continuous duty.
- "U" ground outlets — soldered connections.
- Mounting centers 5 inches.
- 1 1/2 inches wide, 1 1/8 inches deep.
- Supplied with spring clips for internal mounting.
- OB-112 — mounts horizontally onto frame cross brace providing access without interference to sliding chassis or shelf units not directly in line with the 1 3/4 inch wide outlet strip. Also can mount to panel mounting angles or base.

Overall Length (Inches)	Outlets	Catalog Number
12 1/2	6	OB-112
42	8	OB-42-8
52	10	OB-52-10
62	12	OB-62-12

Rack Mount Outlet Strip

- Completely wired with circuit breaker. Ready for use.
- Rated at 15 Amperes, 120 volts.
- Supplied with 15 foot power cord 14/3 SJT, molded plug.
- All components UL listed or recognized.
- Mechanically and electrically grounded.
- Black finish.

Overall Length (Inches)	Outlets	Rack Space (Inches)	Catalog Number
19	6	1 3/4 x 19	OB-119



Economy Surge Suppressor

Unit offers surge voltage protection of 6000 V, clamping surge voltage of 325 V and a clamping response time of 10 nanoseconds (10 x 10⁻⁹ seconds). Maximum surge dissipation is 70 joules repeated usage, self restoring. The unit features an on/off pilot light/master switch, Beige enamel housing, and snap-on mounting clips. UL listed.

Length (Inches)	Width (Inches)	Height (Inches)	Outlets	Cord Length (Feet)	Catalog Number
12 1/4	1 3/4	1 5/8	6	6	OB-115S



OB-112 Shown



Handles And Locks

Material

- Aluminum – QQ-A-325-A
- Black anodize finish per MIL-A-8625 Type II



Non-Locking Handle
Satin chrome plated.
Catalog Number: HW-1

Locking Handle
Supplied with two keys. Satin chrome plated.
Catalog Number: HW-3



Cylinder Lock
Supplied with two keys.
Nickel plated.
Catalog Number: HW-6



Quick Turn Fastener
Nickel plated.
Catalog Number: HW-8

2 Inch, 3 Inch and 4 Inch Casters

Made of non-marking composition wheel with ball bearing swivel plate. Packed one set of four in box with screws for assembly.



Type of Wheel	Wheel Size Dia. x Width (Inches)	Overall Height (Inches)	Catalog Number
Hard Rubber	2 x 1	2 1/2	CA-4
Hard Rubber	3 x 1 1/4	3 13/16	CA-5
Soft Rubber	2 x 1 5/8 (double)	2 13/16	CA-6
Hard Rubber	3 x 1 1/4	3 13/16	CA-7*
Reinforced Thermal Plastic	4 x 2	5 5/8	CA-8**

* Foot operated friction brake for positive locking wheel.
** With roller bearing wheel. Cabinets are not predrilled for CA-8 casters.

Mounting Hardware

Phillips Washer Head Screws and Captive Nuts

Size: 10-32 x 3/4 Inch
Packaged: 20 each/bag.
Catalog Number: HW-14



Phillips Washer Head Screws, Tinnerman Nuts and Nylon Washers

Size: 10 x 1 Inch
Packaged: 8 each/bag.
Catalog Number: HW-15



Phillips Washer Head Screws and Nylon Washer

Packaged: 20 each/bag.

Size (Inches)	Catalog Number
10-32 x 1/2	HW-13
10-32 x 3/4	HW-16



PREMIER enclosures can be finished in two ways as follows:

1 Semi-Gloss Textured

A superior finish with excellent hiding qualities and durability minimizes reflective glare.

2 Semi-Gloss Enamel

A high quality baked finish in standard use for cabinetry.

Premier Color*	Premier Finish Number For:		Fed. Std. Number 595A (Matching Colors)	Premier Color*	Premier Finish Number For:		Fed. Std. Number 595A (Matching Colors)
	Textured	Semi-Gloss Enamel			Textured	Semi-Gloss Enamel	
Charcoal Gray	361	461	36081	Beige Tan	331	431	26521
Dark Gray	362	462	26152	Shadow Green	341	441	24148
Light Gray	363	463	26440	Coral Red	311	411	31302
Hammertone Grey	364	—	—	Autumn Gold	332	432	33434
Bright Blue	351	451	25102	Black	371	471	27038
Smoke Blue	352	452	25189	White	372	472	27886
Light Blue	353	453	35240	Burgundy	373	473	—
Charcoal Brown	301	401	24091				

* These contemporary colors were selected to afford the designer a wide opportunity to create attractive and pleasing color schemes by coordinating, contrasting or harmonizing these standard colors. SPECIAL COLORS ALSO AVAILABLE.

Note: The above colors have been printed to show the color values available. For exact matching, paint chips are available.

*Video Cabinet
with Turret Rack*



*EMI/RFI Shielded
Cabinets*



Courtesy of Lockheed Martin



*Naval Electronics
Simons Enclosure*

Premier Application Engineers can assist you with modified standard products or uniquely designed new enclosures.

Let us work together to solve your enclosure challenges quickly, efficiently and effectively.

Comprehensive fixed-price quotations are promptly and courteously provided.

EMI

Premier engineers EMI shielded enclosures to protect against electromagnetic interference for commercial, military, and high-security applications.

NEMA

Premier builds modified and custom National Electrical Manufacturing Association (NEMA) enclosures to meet unique environmental requirements.

Seismic/Shock/Vibration

Premier designs seismic enclosures to meet shock and vibration requirements. We have the expertise and knowledge to meet special requirements, such as those that stipulate zone four or Belcor specifications.



***Two Bay System with Circuit Breakers /
Rear Doors with Filters***



Paragon Cabinet with Accessories



Fold up Keyboard Shelf - RFK